

PLAN

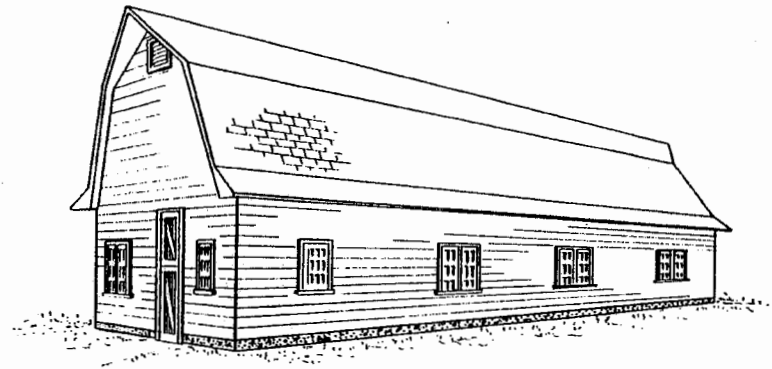

PERSPECTIVE

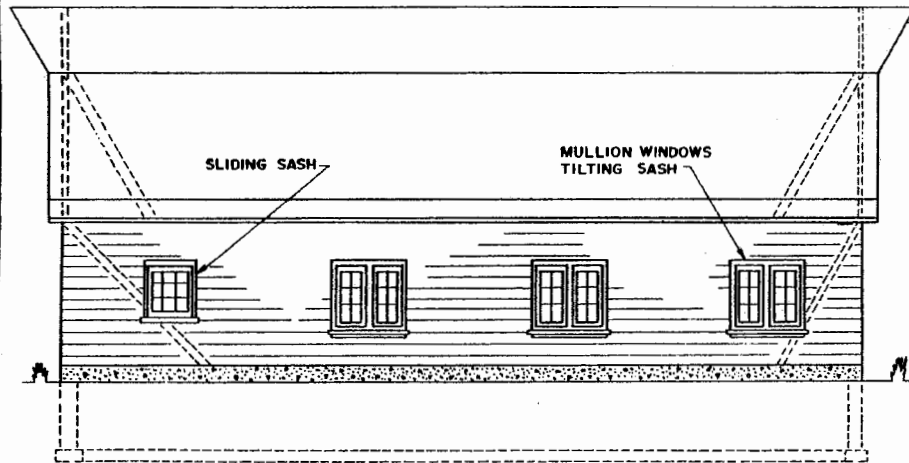

SIDE ELEVATION

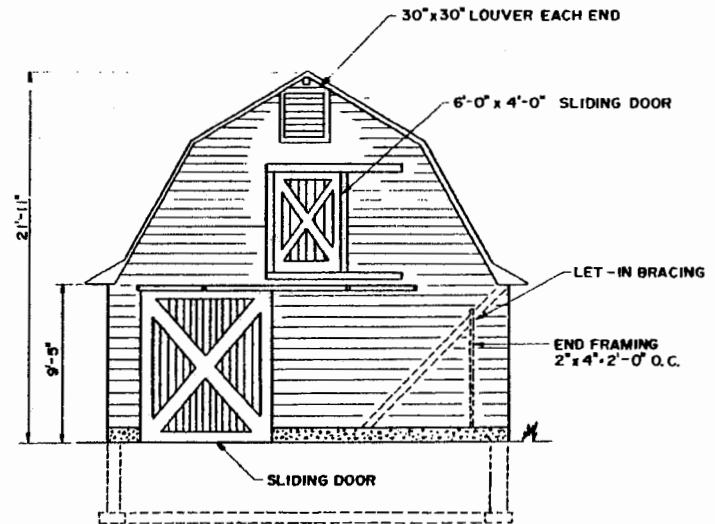

END ELEVATION

NOTE: SCALE  $\frac{1}{8}" = 1'-0"$  UNLESS OTHERWISE STATED.

BASED ON N.J. PLAN N° 142



1½ STORY HORSE BARN

N.J. '67 EX.6024 SHEET 1 OF 3



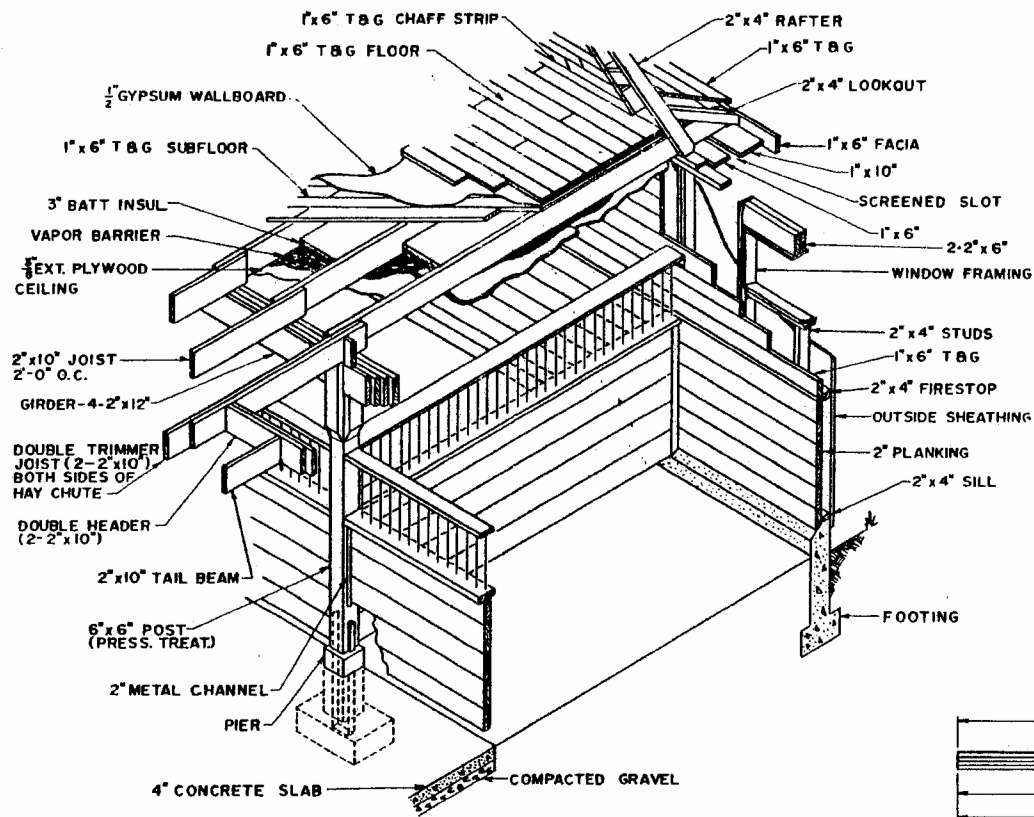

CUTAWAY ISOMETRIC VIEW

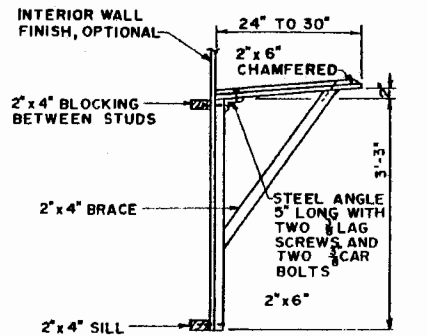

SPACE RACKS 24" TO 30" APART  
SADDLE RACK

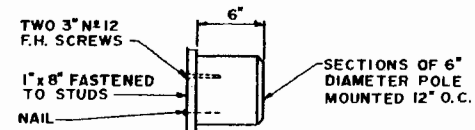

BRIDLE RACK

GIRDER LAMINATION DETAIL

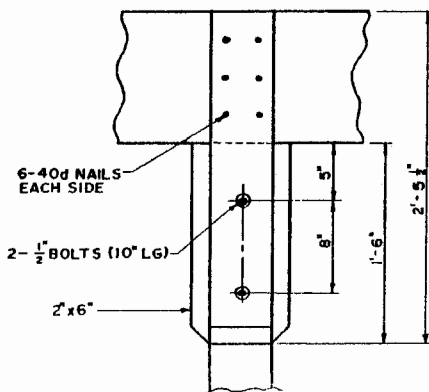
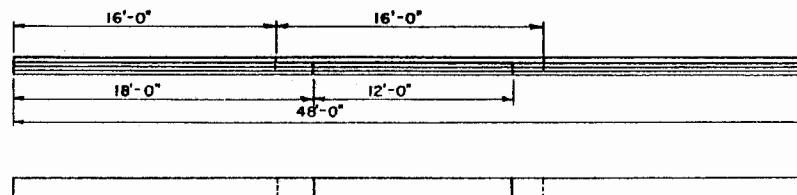

POST & GIRDER DETAIL

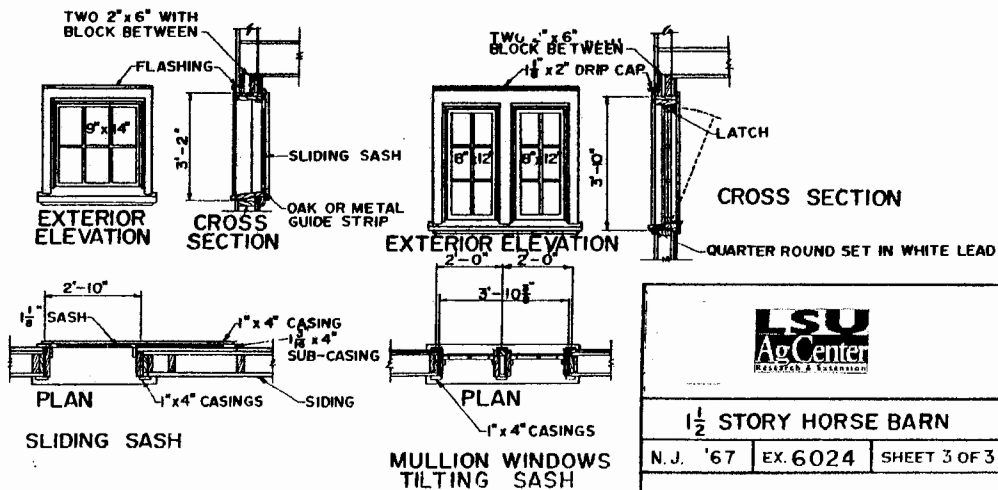
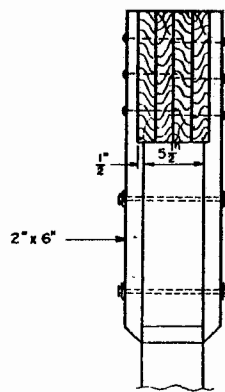

**LSU**  
AgCenter  
RESEARCH & EXTENSION

---

**1/2 STORY HORSE BARN**

N.J. '67 EX. 6024 SHEET 3 OF 3

## Disclaimer

This site makes available conceptual plans that can be helpful in developing building layouts and selecting equipment for various agricultural applications. These plans do not necessarily represent the most current technology or construction codes. They are not construction plans and do not replace the need for competent design assistance in developing safe, legal and well-functioning agricultural building system. The LSU Agriculture Center, the Mid-West Plan Service, the United States Department of Agriculture and none of the cooperating land-grant universities warranty these plans.