

PORTABLE HAY FEEDING FENCE FOR SHEEP

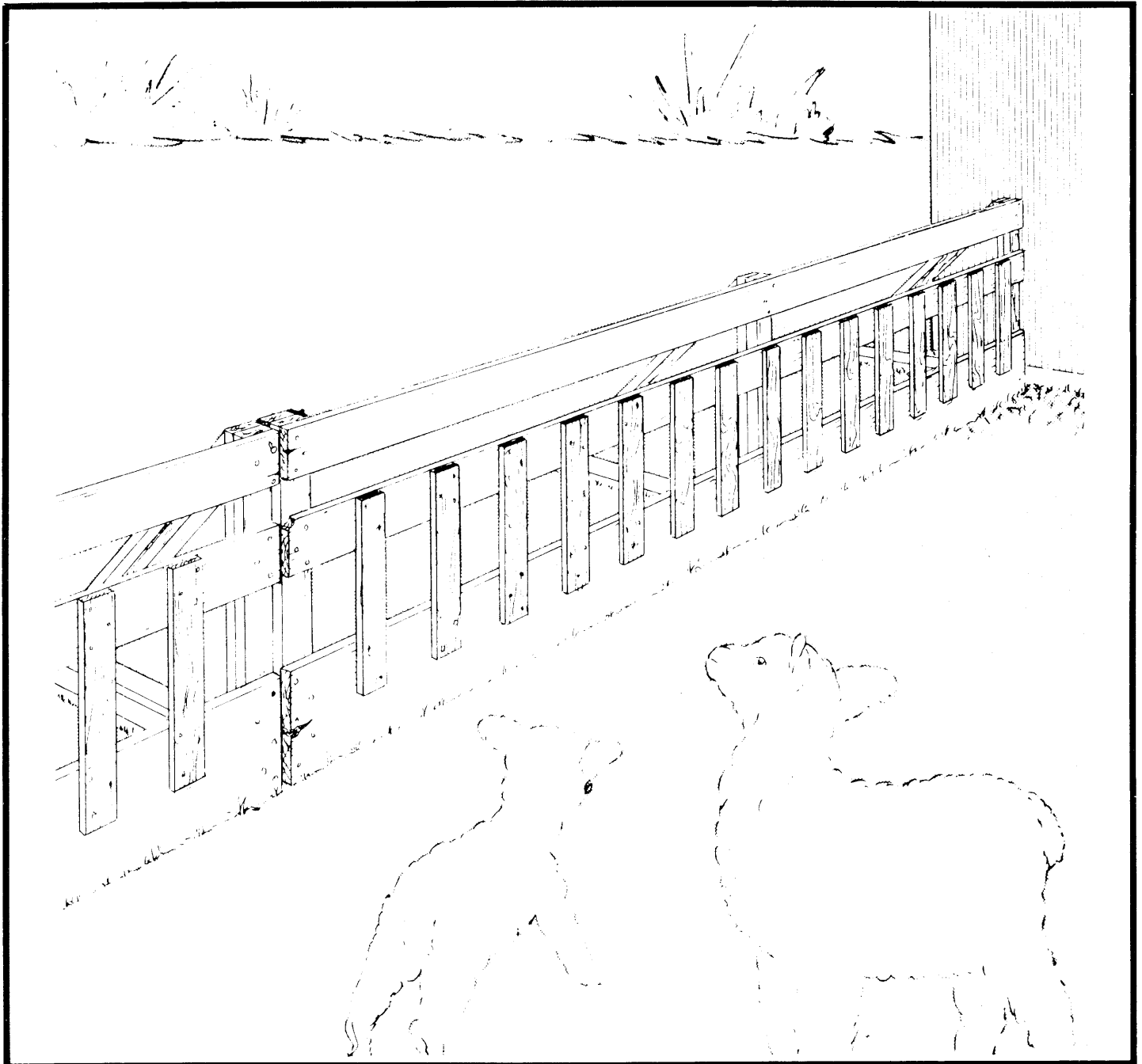

The Canada Plan Service prepares detailed plans showing how to construct modern farm buildings, livestock housing systems, storages and equipment for Canadian Agriculture.

This leaflet gives the details for a farm building component or piece of farmstead equipment. To obtain another copy of this leaflet, contact your local provincial agricultural engineer or extension advisor.

PORTABLE HAY FEEDING FENCE FOR SHEEP

PLAN 4624 (FORMERLY 4413) REVISED 79:07

This plan gives details for a self-supporting fence panel for self-feeding baled or loose hay. Use the panel along the feedlot side of the haystack to control wastage and keep sheep off the haystack. The

height of the throat board and the spaces between the verticals should be made to suit the size of sheep to be fed.

Where this feeding fence is used indoors, some adjustment of overall length may be required to allow the fence panel to fit between building poles.

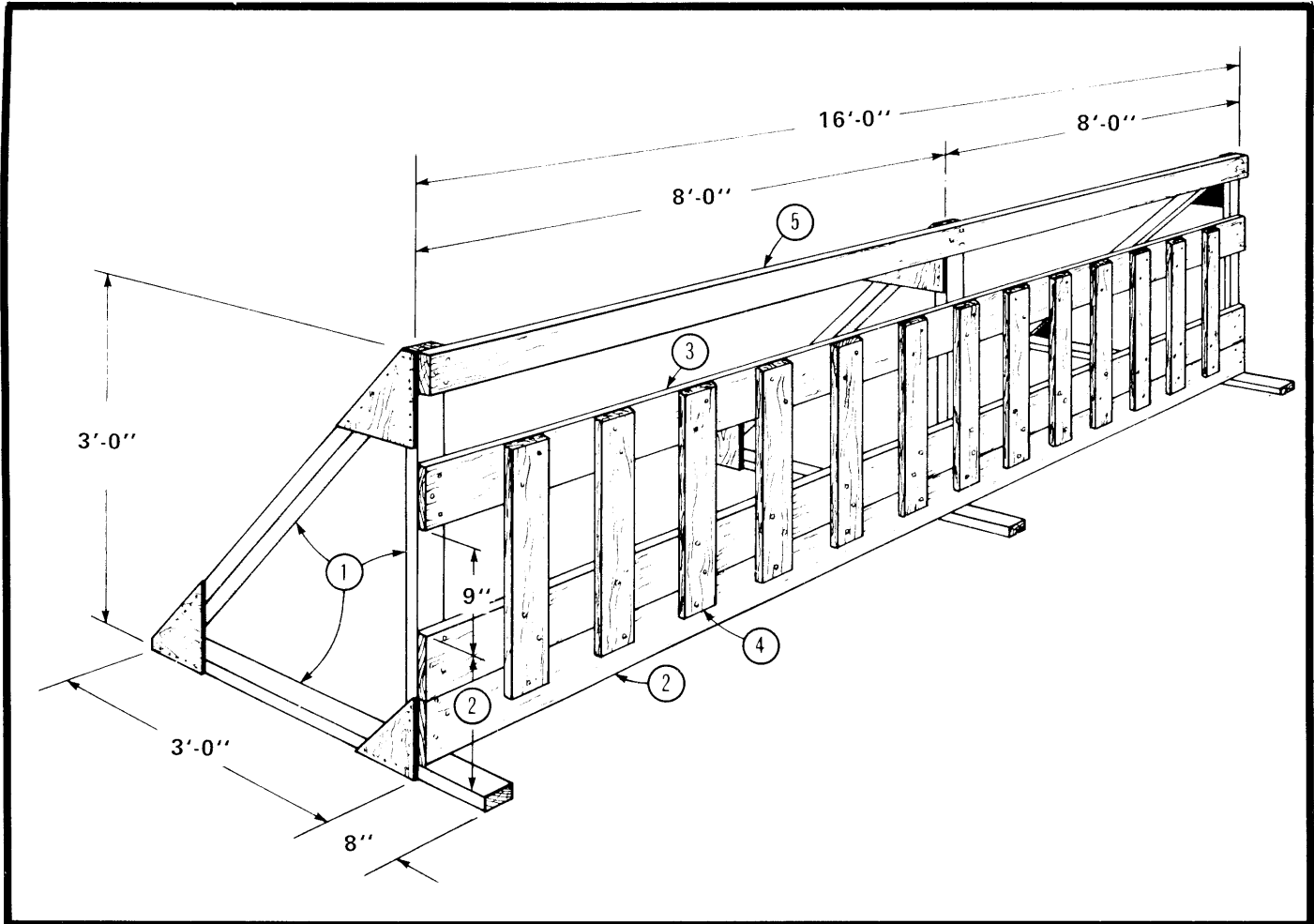

1. 2" x 4 frame with 1/2" plywood gussets
2. 1" throat board, 10" to 12" high for feeder lambs, 12" to 15" for ewes & rams
3. 1" x 6" x 16'
4. 1" x 6" vertical @ 6" min. clear opening for feeder lambs (make 15) or 7 1/2" min. clear opening for ewes & rams (make 13)
5. 2" x 4" x 16'